

# Lipujet P-O

## Avantaje produs

- Stabilitate structurală ridicată, 25 de ani
- Ușor de transportat și de asamblat
- Costuri minime de curățare și întreținere
- Trapă de nămol integrată

- Separator de grăsimi realizat din polietilenă, conform SR EN 1825
- Autoportant, pentru instalare în încăperi fără îngheț
- Formă ovală
- Funcționare dreapta/stânga
- Cu capace etanșe pentru întreținere DN450



## Dimensiuni - echipare de bază

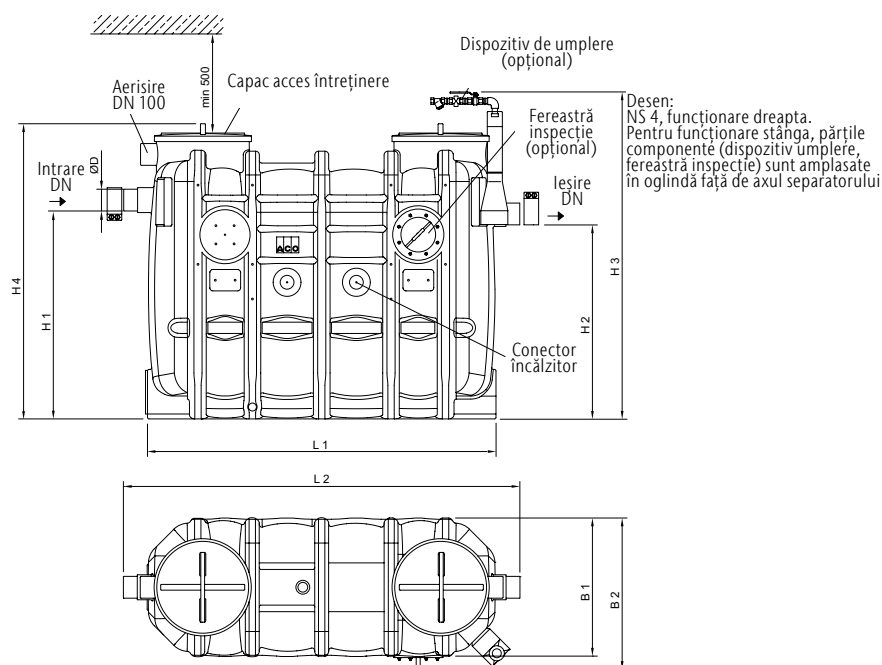

### Debit

### Dimensiuni

	D	L1	L2	H1	H2	H3	H4	H5	B1	B2
	[mm]	[mm]	[mm]	[mm]	[mm]	[mm]	[mm]	[mm]	[mm]	[mm]
NS1	110	1100	1300	830	760	1480	1300	1350	700	770
NS2	110	1100	1300	1055	985	1680	1500	1550	700	770
NS3	110	1450	1650	1055	985	1680	1500	1550	700	770
NS4	110	1760	2000	1055	985	1680	1500	1550	700	770
NSS,5	160	1760	2000	1250	1180	1880	1700	1750	950	1020
NS7	160	1960	2200	1250	1180	1880	1700	1750	950	1020
NS8,5	160	2250	2485	1250	1180	1880	1700	1750	950	1020
NS10	160	2450	2690	1250	1180	1880	1700	1750	950	1020

Debit	DN	Dimensiuni			Greutate		Cod articol
		Capacitate trapă nămol	Depozitare grăsimi	Volum total	Gol	Plin	
		[l]	[l]	[l]	[kg]	[kg]	

#### Lipujet P-O - echipare de bază

NS1	DN 100	106	100	320	62	382	3551.34.00
NS2	DN 100	210	100	440	70	510	3552.34.00
NS3	DN 100	300	150	630	80	710	3553.34.00
NS4	DN 100	400	200	830	95	925	3554.34.00
NS5,5	DN 150	725	360	1430	170	1600	3555.34.00
NS7	DN 150	800	400	1600	187	1787	3557.34.00
NS8,5	DN 150	940	475	1900	208	2108	3558.34.00
NS10	DN 150	1000	520	2000	220	2220	3560.34.00

#### Lipujet P-OD - nivel de echipare 1

NS1	DN 100	106	100	320	68	388	3551.64.00
NS2	DN 100	210	100	440	75	515	3552.64.00
NS3	DN 100	300	150	630	85	715	3553.64.00
NS4	DN 100	400	200	830	100	930	3554.64.00
NS5,5	DN 150	725	360	1430	175	1605	3555.64.00
NS7	DN 150	800	400	1600	193	1793	3557.64.00
NS8,5	DN 150	940	475	1900	214	2114	3558.64.00
NS10	DN 150	1000	520	2000	226	2226	3560.64.00

Debit	DN	Cod articol	
		Funcționare	
		Dreapta	Stânga

#### Lipujet P-OM - nivel de echipare 2

NS1	DN 100	3571.74.41	3571.74.31
NS2	DN 100	3572.74.41	3572.74.31
NS3	DN 100	3573.74.41	3573.74.31
NS4	DN 100	3574.74.41	3574.74.31
NS5,5	DN 150	3575.74.41	3575.74.31
NS7	DN 150	3577.74.41	3577.74.31
NS8,5	DN 150	3578.74.41	3578.74.31
NS10	DN 150	3580.74.41	3580.74.31

#### Lipujet P-OMP nivel de echipare 2 (control manual)

NS1	DN 100	3571.84.41	3571.84.31
NS2	DN 100	3572.84.41	3572.84.31
NS3	DN 100	3573.84.41	3573.84.31
NS4	DN 100	3574.84.41	3574.84.31
NS5,5	DN 150	3575.84.41	3575.84.31
NS7	DN 150	3577.84.41	3577.84.31
NS8,5	DN 150	3578.84.41	3578.84.31
NS10	DN 150	3580.84.41	3580.84.31

Debit	DN	Cod articol	
		Funcționare	
		Dreapta	Stânga







#### Lipujet P-OA - nivel de echipare 3

NS1	DN 100	3551.74.42	3551.74.32
NS2	DN 100	3552.74.42	3552.74.32
NS3	DN 100	3553.74.42	3553.74.32
NS4	DN 100	3554.74.42	3554.74.32
NS5,5	DN 150	3555.74.42	3555.74.32
NS7	DN 150	3557.74.42	3557.74.32
NS8,5	DN 150	3558.74.42	3558.74.32
NS10	DN 150	3560.74.42	3560.74.32

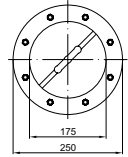
#### Lipujet P-OAP nivel de echipare 3 (control automat)

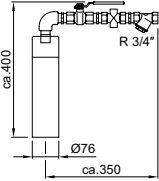
NS1	DN 100	3551.84.42	3551.84.32
NS2	DN 100	3552.84.42	3552.84.32
NS3	DN 100	3553.84.42	3553.84.32
NS4	DN 100	3554.84.42	3554.84.32
NS5,5	DN 150	3555.84.42	3555.84.32
NS7	DN 150	3557.84.42	3557.84.32
NS8,5	DN 150	3558.84.42	3558.84.32
NS10	DN 150	3560.84.42	3560.84.32

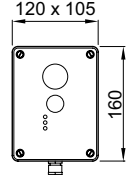
# Accesorii

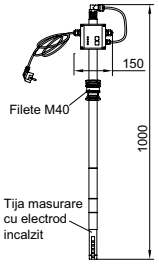
Descriere	Compatibil cu	Descriere	Cod
  <p>Fereastră de inspecție</p>	<ul style="list-style-type: none"> <li>Separator de grăsimi LipuJet-P, -OB, -OD, -RB, -RD</li> </ul>	<ul style="list-style-type: none"> <li>Dimensiune nominală DN 200</li> <li>Cu stergător</li> <li>Greutate: 5 kg</li> </ul>	3300.11.10
  <p>Dispozitiv de umplere</p>	<ul style="list-style-type: none"> <li>Separator de grăsimi LipuJet-P, -OB, -OD, -RB, -RD</li> </ul>	<ul style="list-style-type: none"> <li>Pentru conectare la rețeaua de apă potabilă</li> <li>Cu robinet sferic R 3/4"</li> <li>Cu reductor de presiune</li> <li>Greutate: 3,5 kg</li> </ul>	3300.11.22
  <p>Unitate de control la distanță</p>	<ul style="list-style-type: none"> <li>Separator de grăsimi LipuJet/ -OA, -OAP, -RA, -RAP</li> </ul>	<ul style="list-style-type: none"> <li>Pentru asamblare în interior</li> <li>Cablu de control fără protecție</li> <li>Pentru 50 m: <ul style="list-style-type: none"> <li>7 x 1,0 mm<sup>2</sup></li> </ul> </li> <li>50 – 200 m: <ul style="list-style-type: none"> <li>7 x 1,5 mm<sup>2</sup></li> </ul> </li> <li>Grad de protecție IP 54</li> <li>Greutate: 1 kg</li> </ul>	0150.59.89
  <p>Senzor de nivel pentru grăsimi</p>	<ul style="list-style-type: none"> <li>LipuJet-P <ul style="list-style-type: none"> <li>Oval NS 1-10</li> <li>Rotund NS 2-20</li> </ul> </li> <li>LipuJet-S <ul style="list-style-type: none"> <li>Oval NS 1-10</li> <li>Rotund NS 2-20</li> </ul> </li> </ul>	<ul style="list-style-type: none"> <li>Dispozitiv de măsurare a stratului de grăsime pentru separatoare de grăsimi cu montaj îngropat</li> <li>Poate măsura nivelul de grăsimi lichide și întărite</li> <li>Echipat cu două contacte libere de potențial pentru raportare către sistemul de monitorizare al clădirii a gradului de umplere la 50% și la 80%</li> <li>Senzor cu cap încălzit pentru împiedicarea întăririi grăsimii</li> <li>Conexiune electrică: <ul style="list-style-type: none"> <li>230 V AC/50Hz/12W</li> </ul> </li> </ul>	3300.11.50