

Element de rigola fara panta prefabricata, cu muchie de protectie din polipropilena, L=1m, C250

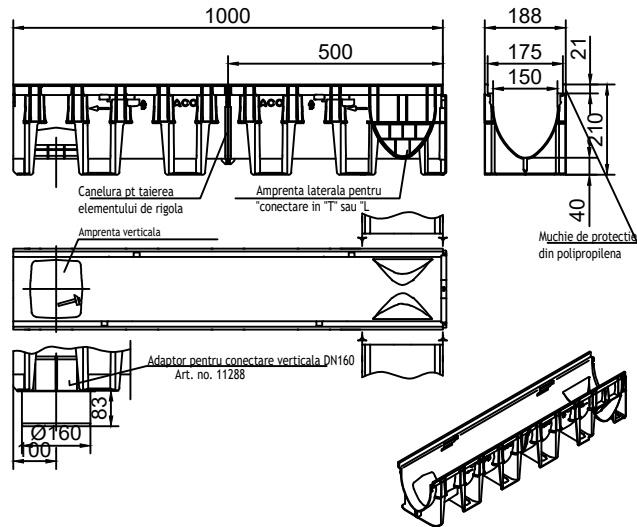

Lungime de montaj [mm]	Diametrul nominal [mm]	Lungime de montaj [mm]	Inaltime de montaj [mm]	Muchie de protectie din polipropilena
1000	150	188	210	Art. no. 11011

Element de rigola fara panta prefabricata, cu muchie de protectie din otel zincat, L=1m, D400

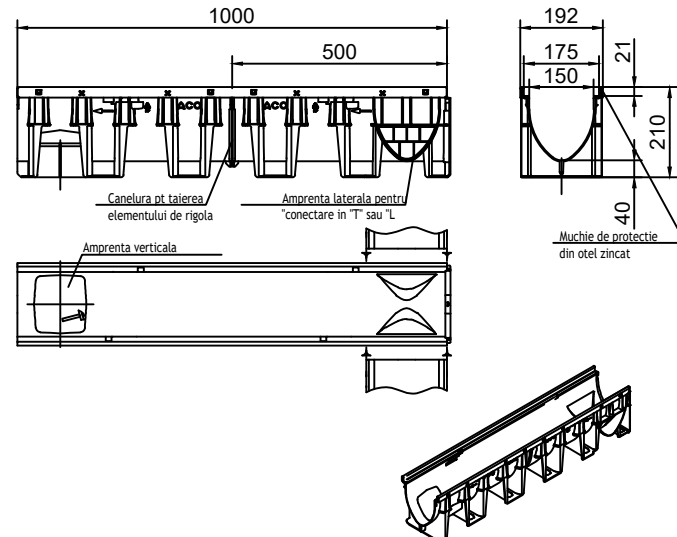

Lungime de montaj [mm]	Diametrul nominal [mm]	Lungime de montaj [mm]	Inaltime de montaj [mm]	Muchie de protectie din otel zincat
1000	150	192	210	Art. no. 11111

Placa de capat amonte/aval

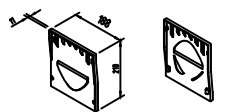

Diametrul nominal [mm]	Art. no.
150	11093

Placa de capat amonte/aval cu granitura DN150

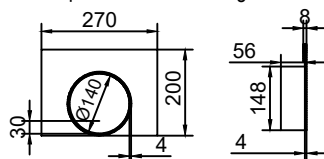

Diametrul nominal [mm]	Art. no.
150	11094

Camin de colectare

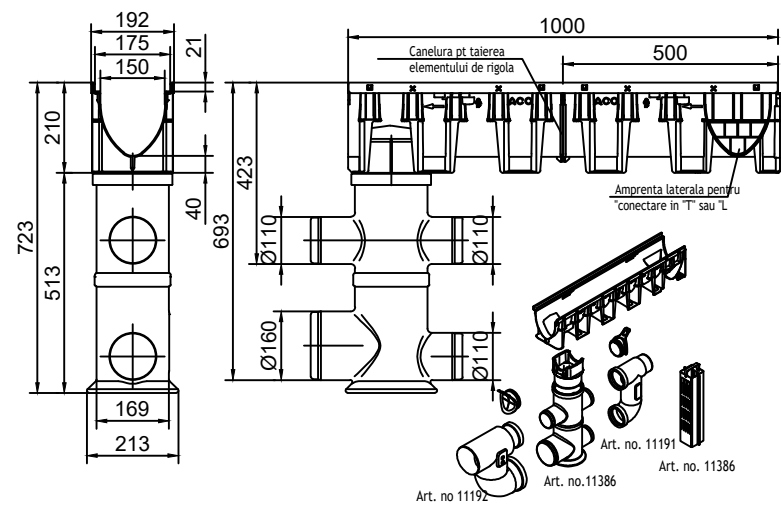

Diametrul nominal [mm]	Inaltime de montaj [mm]	Art. no.
150	512	11386

Element de conectare verticala
Art. 11288

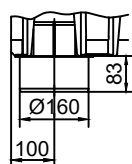

Numele sistemului: ACO XtraDrain	Scara: 1:10	
Denumirea plansei: ACO XtraDrain X150 C/S - clasa de sarcini A15 - C250/D400	Data: 06/2021	
Nume fisier: Rigola X150 C/S.dwg	Revizia nr. 0	
Caracteristici tehnice Rigolele ACO XtraDrain sunt fabricate din polipropilena, cu muchie de protectie din polipropilena sau otel zincat, cu sectiune de curgere in forma de "V", cu clasa de sarcini pana la D400 conform SR EN 1433	Desenat Alexandra Alexa	
		<p style="text-align: center;">ACO srl</p> <p style="text-align: center;">Departamentul tehnic</p> <p style="text-align: center;">www.aco.ro tehnic@aco.ro</p>